

# SECTION B DRAWER & RUNNERS SECTION



www.lga.info  
ID 1111227769

CEMUX

CEMUX

**CETECH-MOVE**  
The excellent benefits

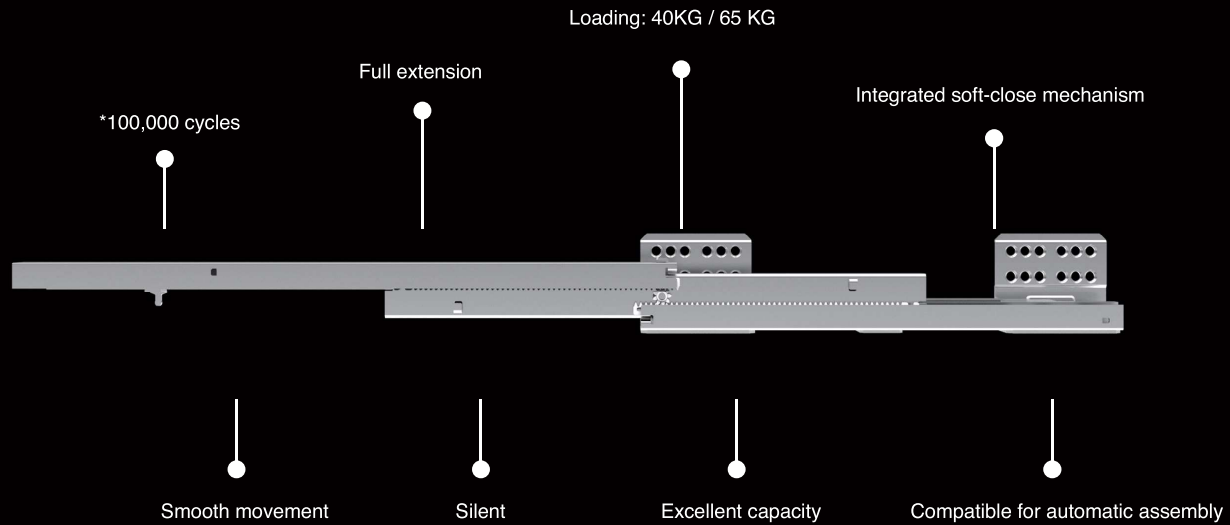

\*100,000 cycles with 40kg loading tested regarding to standard: EN 15338 and BS6222-2:2009 + A1:2017 Test level H (cutlery drawer)

# “Flexible drawer system to meet any requirements”

Drawer range offers flexibility, function and aesthetics with an outstanding running system..



Legend			
LW	Internal cabinet width	L	Length
NL	Nominal length	SKL	Length of drawer
		KB	Cabinet width
		LT	Minimum installation depth
		X	Thickness of door
		FEC	Front edge of cabinet

## A box

### Contempo drawer side H84 - A3201



- Contempo wall
- Soft-close
- Full extension
- 84 mm drawer height
- $\pm 2$ mm up & down adjustment;
- $\pm 1.5$ mm left & right adjustment
- Length from 270-550mm
- Cycles with loading 40kg is 100,000
- Loading capacity is 40kg

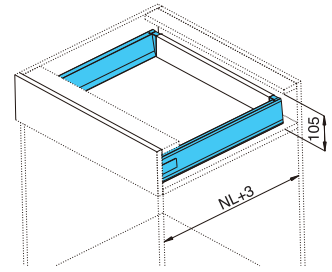

Components	NL	White	Grey	Package
	270	-	A3201-270G	6 sets
	300	-	A3201-300G	6 sets
	350	-	A3201-350G	6 sets
	400	-	A3201-400G	6 sets
	450	-	A3201-450G	6 sets
	500	-	A3201-500G	6 sets
	550	-	-	6 sets

## A box

### Contempo drawer side with square rail H199 - A3204



- Contempo wall
- Soft-close
- Full extension
- 199 mm drawer height
- $\pm 2$ mm up & down adjustment;
- $\pm 1.5$ mm left & right adjustment
- Length from 270-550mm
- Cycles with loading 40kg is 100,000
- Loading capacity is 40kg

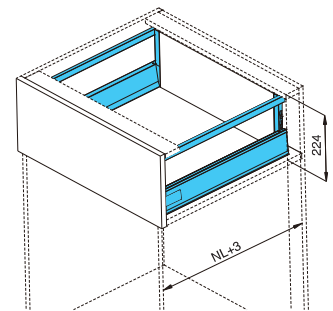

Components	NL	White	Grey	Package
	270	-	-	6 sets
	300	-	-	6 sets
	350	-	-	6 sets
	400	-	-	6 sets
	450	-	A3204-450G	6 sets
	500	-	A3204-500G	6 sets
	550	-	-	6 sets

## A box

Contempo drawer side with glass panel H199 - A3244



B



- Contempo wall
- Soft-close
- Full extension
- 199 mm drawer height
- $\pm 2$ mm up & down adjustment;
- $\pm 1.5$ mm left & right adjustment
- Length from 350-550mm
- Cycles with loading 40kg is 100,000
- Loading capacity is 40kg

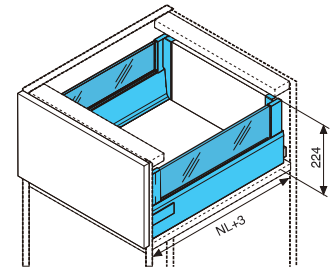

Components	NL	Frosted		Package
		White	Grey	
	270	-	-	-
	300	-	-	-
	350	-	-	6 sets
	400	-	-	6 sets
	450	-	A3244-450GF	6 sets
	500	-	A3244-500GF	6 sets
	550	-	-	6 sets

## A box

Inset drawer accessories for H84

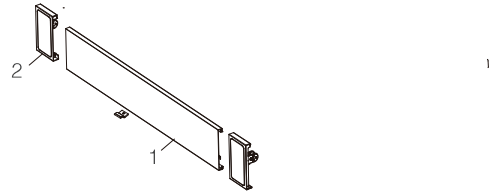

### Order information

1. Front panel - normal aluminum  
\* DIY cut : Length = LW-90

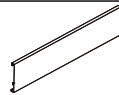

L	White	Grey
1200	-	AL321200G

2. Inset drawer front bracket left/right  
(for inset drawer H84)

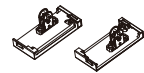

	White	Grey
	-	AH320101G

## A box

Inset drawer accessories for H199

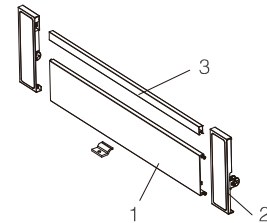

### Order information

1. Front panel - normal aluminum  
\* DIY cut : Length = LW-90

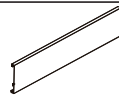

L	White	Grey
1200	-	AL321200G

2. Inset drawer front bracket left/right  
(for inset drawer H199 with square rail)



	White	Grey
	-	AF320401G

3. Front square rail  
\* DIY cut : Length = LW-92



L	White	Grey
1200	-	HF321200G

## H box

### Drawer H84 - H1301



B



- Slim wall
- Soft-close
- Full extension
- 84 mm drawer height
- ±2mm up & down adjustment;
- ±1.5mm left & right adjustment
- Length from 270-550mm
- Cycles with loading 40kg is 100,000
- Loading capacity is 40 KG

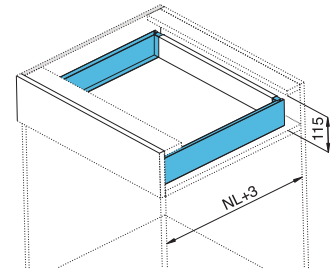

Components	NL	White	Grey	Package
	270	-	H1301-270G	6 sets
	300	-	H1301-300G	6 sets
	350	-	H1301-350G	6 sets
	400	-	H1301-400G	6 sets
	450	H1301-450W	H1301-450G	6 sets
	500	H1301-500W	H1301-500G	6 sets
	550	-	-	6 sets

## H box

### Drawer H167 - H1303



- Slim wall
- Soft-close
- Full extension
- 167 mm drawer height
- ±2mm up & down adjustment;
- ±1.5mm left & right adjustment
- Length from 270-550mm
- Cycles with loading 40kg is 100,000
- Loading capacity is 40 KG

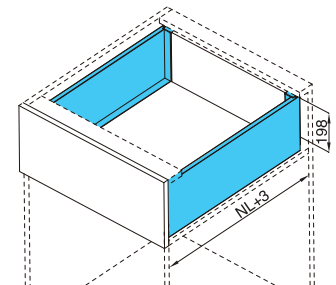

Components	NL	White	Grey	Package
	270	-	-	5 sets
	300	-	-	5 sets
	350	-	H1303-350G	5 sets
	400	-	H1303-400G	5 sets
	450	-	H1303-450G	5 sets
	500	-	H1303-500G	5 sets
	550	-	-	5 sets

## H box

### Drawer H199 - H1304



- Slim wall
- Soft-close
- Full extension
- 199 mm drawer height
- $\pm 2$ mm up & down adjustment;
- $\pm 1.5$ mm left & right adjustment
- Length from 270-550mm
- Cycles with loading 40kg is 100,000
- Loading capacity is 40 KG

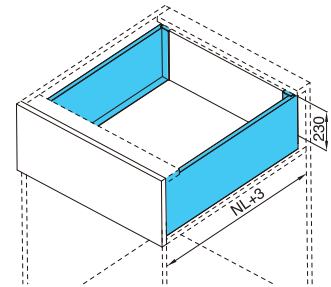

Components	NL	White	Grey	Package
	270	-	-	4 sets
	300	-	-	4 sets
	350	-	-	4 sets
	400	-	H1304-400G	4 sets
	450	-	H1304-450G	4 sets
	500	H1304-500W	H1304-500G	4 sets
	550	-	-	4 sets

## H box

### Drawer glass side H84 - H1311



- Slim glass wall
- Soft-close
- Full extension
- 84 mm drawer height
- $\pm 2$ mm up & down adjustment;
- $\pm 1.5$ mm left & right adjustment
- Length from 350-550mm
- Cycles with loading 40kg is 100,000
- Loading capacity is 40 KG

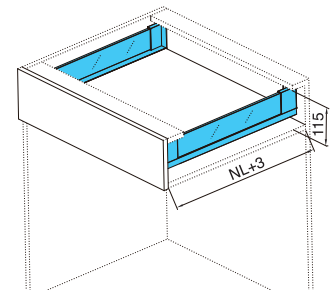

Components	NL	White	Grey	Package
	270	-	-	6 sets
	300	-	-	6 sets
	350	-	-	6 sets
	400	-	-	6 sets
	450	-	H1311-450G	6 sets
	500	-	H1311-500G	6 sets
	550	-	-	6 sets

## H box

### Drawer glass side H167 - H1313



B



- Slim glass wall
- Soft-close
- Full extension
- 167 mm drawer height
- ±2mm up & down adjustment;
- ±1.5mm left & right adjustment
- Length from 350-550mm
- Cycles with loading 40kg is 100,000
- Loading capacity is 40 KG

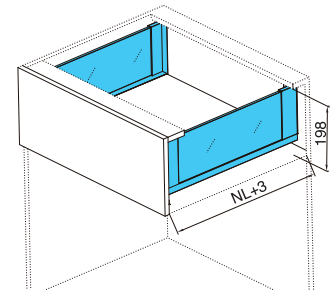

Components	NL	White	Grey	Package
	270	-	-	6 sets
	300	-	-	6 sets
	350	-	-	6 sets
	400	-	-	6 sets
	450	-	H1313-450G	6 sets
	500	-	H1313-500G	6 sets
	550	-	-	6 sets

## H box

### Drawer glass side H199 - H1314



- Slim glass wall
- Soft-close
- Full extension
- 199 mm drawer height
- ±2mm up & down adjustment;
- ±1.5mm left & right adjustment
- Length from 350-550mm
- Cycles with loading 40kg is 100,000
- Loading capacity is 40 KG

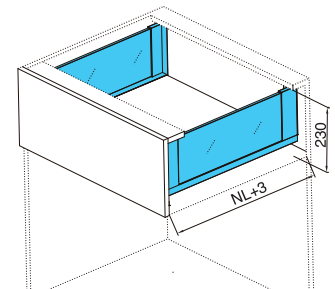

Components	NL	White	Grey	Package
	270	-	-	6 sets
	300	-	-	6 sets
	350	-	-	6 sets
	400	-	-	6 sets
	450	-	H1314-450G	6 sets
	500	-	H1314-500G	6 sets
	550	-	-	6 sets

## H box

Inset drawer accessories for H84

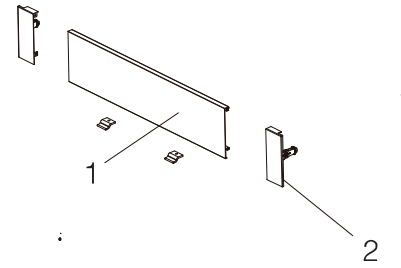

### Order information

1. Front panel - normal aluminum  
\* DIY cut : Length = LW-100

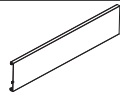

L	White	Grey
1200	-	H1321200G

2. Inset drawer front bracket left/right



	White	Grey
	-	H130200G

## H box

Inset drawer - Front panel and H54 glass for drawer H84

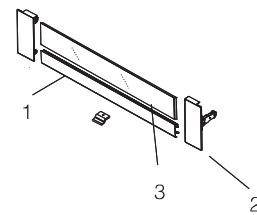

### Order information

1. Front panel - low aluminum  
\* DIY cut : Length = LW-100



L	White	Grey
1200	-	H1331200G

2. Inset drawer front bracket left/right



	White	Grey
	-	H131200G

3. Front H54 glass panel



KB	Frosted	Transparent
600	H1410476F	-
800	H1410676F	-
900	H1410776F	-

## H box

Inset drawer - Front panel and rail for drawer H167

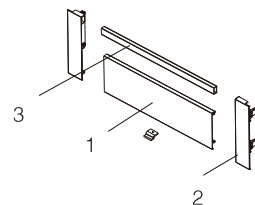

### Order information

1. Front panel - normal aluminum  
\* DIY cut : Length = LW-100

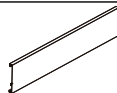

L	White	Grey
1200	-	H1321200G

2. Inset drawer front bracket left/right



	White	Grey
	-	H130500G

3. Front square rail  
\* DIY cut : Length = LW-88



L	White	Grey
1200	-	HF321200G

## H box

Inset drawer - Front panel and rail for drawer H199

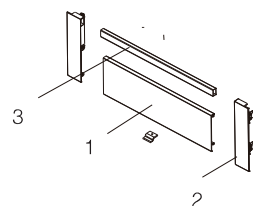

### Order information

1. Front panel - normal aluminum  
\* DIY cut : Length = LW-100

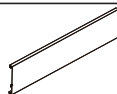

L	White	Grey
1200	-	H1321200G

2. Inset drawer front bracket left/right



	White	Grey
	-	H130800G

3. Front square rail  
\* DIY cut : Length = LW-88



L	White	Grey
1200	-	HF321200G

## H box

Inset drawer - Front panel and H102 glass for drawer glass side H199

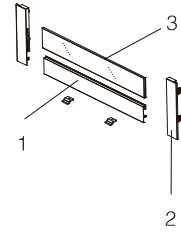

### Order information

1. Front panel - low aluminum  
\* DIY cut : Length = LW-100

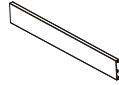

L	White	Grey
1200	-	H1331200G

2. Inset drawer front bracket left/right



	White	Grey
	-	H130600G

3. Front H102 glass panel

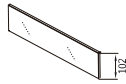

KB	Frosted	Transparent
600	H1390476F	-
800	H1390676F	-
900	H1390776F	-